

# Bus module BCM 400..B1 PROFIBUS for BCU 4xx

## OPERATING INSTRUCTIONS

· Edition 03.24 · EN · 03251598



### CONTENTS

1 Safety . . . . .	1
2 Checking the usage . . . . .	2
3 Installation . . . . .	2
4 Replacement . . . . .	3
5 Wiring . . . . .	3
6 Commissioning . . . . .	3
7 Assistance in the event of malfunction . . . . .	5
8 Technical data . . . . .	6
9 Logistics . . . . .	6
10 Disposal . . . . .	6

### 1 SAFETY

#### 1.1 Please read and keep in a safe place



Please read through these instructions carefully before installing or operating. Following the installation, pass the instructions on to the operator. This unit must be installed and commissioned in accordance with the regulations and standards in force. These instructions can also be found at [www.docuthek.com](http://www.docuthek.com).

#### 1.2 Explanation of symbols

**1, 2, 3, a, b, c** = Action

→ = Instruction

#### 1.3 Liability

We will not be held liable for damage resulting from non-observance of the instructions and non-compliant use.

#### 1.4 Safety instructions

Information that is relevant for safety is indicated in the instructions as follows:

#### DANGER

Indicates potentially fatal situations.

#### WARNING

Indicates possible danger to life and limb.

#### CAUTION

Indicates possible material damage.

All interventions may only be carried out by qualified gas technicians. Electrical interventions may only be carried out by qualified electricians.

#### 1.5 Conversion, spare parts

All technical changes are prohibited. Only use OEM spare parts.

## 2 CHECKING THE USAGE

The bus module BCM 400..B1 is used as a communication interface for burner control units BCU 460, BCU 465 or BCU 480 for connection to a fieldbus interface via PROFIBUS.

Networking via the fieldbus enables the BCUs to be controlled and monitored by an automation system (e.g. PLC). The communication network must be protected against unauthorized access.

This function is only guaranteed when used within the specified limits – see page 6 (8 Technical data). Any other use is considered as non-compliant.

### 2.1 Type code

BCM	Bus module
<b>400</b>	Series 400
<b>S0</b>	Standard communication
<b>S1</b>	SafetyLink
<b>B1</b>	PROFIBUS DP
<b>B2</b>	PROFINET
<b>B3</b>	EtherNet/IP
<b>B4</b>	Modbus TCP
<b>/1</b>	9-pin D-Sub
<b>/3</b>	Two RJ45 sockets
<b>-0</b>	–
<b>-3</b>	Three-point step control via bus

### 2.2 Part designations

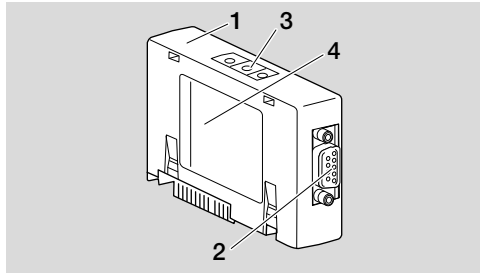

- 1 BCM../1 with 9-pin D-Sub connection
- 2 9-pin D-Sub connection
- 3 Code switches
- 4 Type label

### 2.3 Type label

Ambient temperature ( **A + B** ) – see type label.



## 3 INSTALLATION

- 1 Disconnect the BCU from the electrical power supply.
- 2 Open the cover of the BCU.
- 3 Insert the bus module in the slot provided.

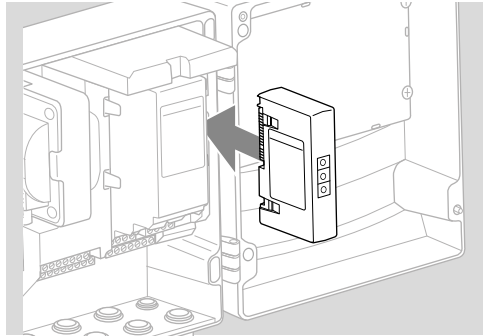

## 4 REPLACEMENT

- 1 Disconnect the BCU from the electrical power supply.
- 2 Open the cover of the BCU.
- 3 Remove the connection plug from the power and bus module.
- 4 Remove the modules in the following order to facilitate handling:
  1. Power module,
  2. Bus module.

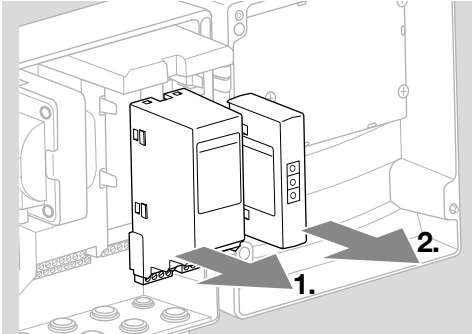

→ Installation of the modules in reverse order.

## 5 WIRING

→ PROFIBUS installation guidelines, see [www.profibus.com](http://www.profibus.com).

- 1 Do not confuse data cables A and B in the PROFIBUS plug.

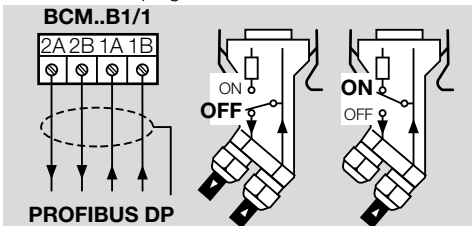

- 2 Connect the shield on both sides and over a wide area with shield clips in the plug.
- Ensure there is an equipotential bond between the devices.
- 3 Switch on the terminal resistors on the first and last subscriber in the segment.
  - 4 Wire control signals that are relevant for safety, such as the safety interlocks and high temperature, separately.
- The purge signals can be transferred via the bus communication or by a separate cable via terminal.
- Protect the communication network against unauthorized access.

## 6 COMMISSIONING

### ⚠ WARNING

Risk of explosion!

Do not enable the BCM and control unit (BCU) for operation until the parameter settings and wiring are correct and the faultless processing of all input and output signals has been ensured.

In the event that the bus communication is faulty or interrupted, or the communications data is invalid, or during initialization, the signals received from the controller are interpreted as "0". If the control unit is activated using the inputs at the terminals during this time, the normal program runs. Be sure to take the settings of parameters A085 to A089 into account.

- Fieldbus communication can be configured using the engineering tool of the automation system.
- The BCSoft operating instructions and software can be downloaded from [www.docuthek.com](http://www.docuthek.com).
- 1 Set parameter A080 = 2 (Fieldbus communication without address check).
  - 2 Check the code switch settings (001 to 125) on the BCM for PROFIBUS communication between BCSoft and the control unit.

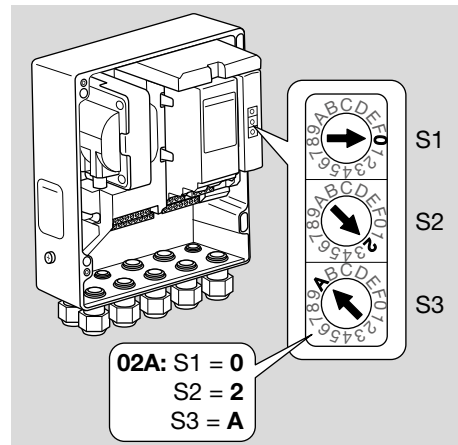

- Each code switch setting combination may only exist once within the fieldbus system.
- Each device name/network name may only be allocated once within the fieldbus system.
- All the device-specific parameters for the BCM..B1 are saved in the device master data file (GSD); download from [www.docuthek.com](http://www.docuthek.com).
- 3 Copy the GSD file.
- The steps required to copy the file are described in the instructions for the automation system.
- 4 Configure the PROFIBUS DP using the appropriate tools for the automation system you are using.
- The BCM..B1 will automatically identify the baud rate – max. 1.5 Mbit/s.

→ The max. range per segment depends on the baud rate:

Baud rate [kbit/s]			
93.75	187.5	500	1500
Range [m (ft)]			
1200 (3937)	1000 (3280)	(1312)	(656)

→ For instructions on commissioning the control unit, see operating instructions "Burner control unit BCU 46x, 480".

→ The ranges can be increased by using repeaters. No more than three repeaters should be connected in series.

→ The BCU with BCM..B1 indicates -- when the mains switch has been switched off. This signals Standby mode. Bit 6 = 0. The bus interface is still supplied with voltage to maintain the function of the communications system. The control outputs of the BCU (valves, ignition transformer) are electrically isolated from the mains voltage.



**5** Apply voltage to the terminals.









**6** Switch on the BCU.

→ The display -- will go out.



→ Bit 6 of input byte 0 is set.



**7** Start the PROFIBUS communication.













→ As soon as the flashing display n  goes out and the indication  appears in the display, the data traffic is operating.

Input bytes (BCU → master)					
Bit	Byte 0	Byte 1	Byte 2	Byte 3	Byte 4
0		Re-served	1)	2)	3)
1		Re-served	1)	2)	3)
2		Re-served	1)	2)	3)
3	 on	Re-served	1)	2)	3)
4	 on	Re-served	1)	2)	3)
5	 on	Re-served	1)	2)	3)
6		Re-served	1)	2)	3)
7		Re-served	1)	2)	3)

1) Program status and fault messages  
 2) 0–255 steps (0–25.5 μA)  
 3) 0–255 steps (0–25.5 μA)

Output bytes (master → BCU)	
Bit	Byte 0
0	
1	 

Output bytes (master → BCU)	
Bit	Byte 0
2	
3	
4	
5	Reserved
6	Reserved
7	Reserved

Legend	
	Operating signal, (pilot) burner
	Operating signal, main burner
	Fault message
 on	Operating signal, air actuator
 on	Purge operating signal
 on	High temperature operation
	Ready for operation
	Manual mode
	Reset
	Start-up signal
	External air actuator control
	Purge

**8** Start the program for the burner/pilot burner: set bit 1 of output byte 0.

→ The BCU starts the burner according to the presets.

## 7 ASSISTANCE IN THE EVENT OF MALFUNCTION

### DANGER

Electric shocks can be fatal!  
Before working on possible live components, ensure the unit is disconnected from the power supply.  
Fault-clearance must only be undertaken by authorized trained personnel.

- Faults may be cleared only using the measures described below.
- If the control unit BCU does not respond even though all faults have been remedied: remove the unit and return it to the manufacturer for inspection.
- If a fault message (n 0) is active, the control unit can continue to be operated via its digital inputs.

### ? Faults

- ! Cause
  - Remedy



### ? The display on the control unit blinks and indicates n 0.

- ! No connection established between BCU and PLC.
  - Check the wiring.
  - Check the PLC program to ensure that the network name and IP configuration of the BCU are valid.
  - Switch on the PLC.

Or

### ? A bus fault is indicated on the automation system.

- ! The PROFIBUS DP data traffic has suffered a fault.
- ! Bus cable interrupted.
  - Check cable.
- ! Incoming and outgoing bus cables confused in the plug.
  - Check the wiring.
- ! A and B cables confused.
  - Check the wiring.
- ! Terminal resistors connected incorrectly.
  - Switch on the terminal resistors on the first and last subscriber in the segment and switch them off for all other subscribers.
- ! Incorrect PROFIBUS address set.
  - Correct the address setting – switch the unit off and then on again to save the address.
- ! Bus cables too long.

- Reduce cable length or baud rate – see page 3 (6 Commissioning).

→ If the transfer rate is reduced, remember that this will increase the signal running times to and from the individual units.

- ! Poor shielding.
  - Check whether the shield is connected to the shield clips in the PROFIBUS DP plugs in full and over a wide area.
- ! Poor equipotential bond.
  - Check whether the PROFIBUS DP shield is connected at all points to the same ground potential via the grounding system of the units.
  - If necessary, an equipotential bonding cable must be laid.
- If faults occur sporadically in the PROFIBUS DP system, and are only indicated briefly in the bus master, the following points in particular should be checked:
  - Terminal resistors,
  - Shield,
  - Cable lengths/routes,
  - Equipotential bond,
  - Use of interference-suppressed spark electrode terminal boots (1 kΩ).
- For information on planning and the structure of a PROFIBUS network and the components to be used (e.g. cables, lines and switches), see [www.profibus.com](http://www.profibus.com) or the instructions for the automation system.

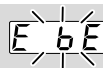

### ? The display on the control unit blinks and indicates E b E.

- ! Internal communication with bus module has suffered a fault.
  - Connected control elements must be equipped with protective circuits in accordance with the manufacturer's instructions.
- This prevents high voltage peaks which can cause malfunctioning of the BCU.
  - Use interference-suppressed terminal boots (1 kΩ).
  - If the fault cannot be remedied by doing this, remove the unit and return it to the manufacturer for inspection.
- ! Bus module is defective.
  - Replace the bus module.

**For other control unit fault messages, see [BCU 46x\\_480 operating instructions](#), section entitled “Assistance in the event of malfunction”.**

## 8 TECHNICAL DATA

### Electrical data

Power consumption: 1.2 VA.

Power loss: 0.7 W.

### Mechanical data

Dimensions (W × H × D):

96 × 63 × 23 mm (3.78 × 2.48 × 0.91 inch).

Weight: 0.3 kg.

### Ambient conditions

Avoid direct sunlight or radiation from red-hot surfaces on the unit.

Avoid corrosive influences, e.g. salty ambient air or SO<sub>2</sub>.

The unit may only be stored/installed in enclosed rooms/buildings.

This unit is not suitable for cleaning with a high-pressure cleaner and/or cleaning products.

Ambient temperature:

-20 to +70°C (-4 to +158°F),

no condensation permitted.

Transport temperature = ambient temperature.

Storage temperature: -20 to +70°C (-4 to +158°F).

Enclosure: IP 20 pursuant to IEC 529.

Installation location: min. IP 65 (for installation in BCU 4xx).

Permitted operating altitude: < 2000 m AMSL.

### 8.1 Designed lifetime

Max. service life under operating conditions:

20 years after date of production.

## 9 LOGISTICS

### Transport

Protect the unit from external forces (blows, shocks, vibration).

Transport temperature: see page 6 (8 Technical data).

Transport is subject to the ambient conditions described.

Report any transport damage on the unit or packaging without delay.

Check that the delivery is complete.

### Storage

Storage temperature: see page 6 (8 Technical data).

Storage is subject to the ambient conditions described.

Storage time: 6 months in the original packaging before using for the first time. If stored for longer than this, the overall service life will be reduced by the corresponding amount of extra storage time.

## 10 DISPOSAL

Devices with electronic components:

**WEEE Directive 2012/19/EU – Waste Electrical and Electronic Equipment Directive**



At the end of the product life (number of operating cycles reached), dispose of the packaging and product in a corresponding recycling center. Do not dispose of the unit with the usual domestic refuse. Do not burn the product.

On request, old units may be returned carriage paid to the manufacturer in accordance with the relevant waste legislation requirements.

## FOR MORE INFORMATION

The Honeywell Thermal Solutions family of products includes Honeywell Combustion Safety, Eclipse, Exothermics, Hauck, Kromschroder and Maxon. To learn more about our products, visit [ThermalSolutions.honeywell.com](https://ThermalSolutions.honeywell.com) or contact your Honeywell Sales Engineer.

Elster GmbH  
Strothweg 1, D-49504 Lotte  
T +49 541 1214-0  
[hts.lotte@honeywell.com](mailto:hts.lotte@honeywell.com)  
[www.kromschroeder.com](http://www.kromschroeder.com)

Global centralized service deployment coordination:  
T +49 541 1214-365 or -555  
[hts.service.germany@honeywell.com](mailto:hts.service.germany@honeywell.com)

Translation from the German  
© 2024 Elster GmbH